

A close-up photograph of white and pink Ergoline equipment components. The word "Ergoline" is written in red cursive on a white surface. The background is dark blue.

PRICELIST 04/2017

EQUIPMENT & PRICES

ERGOLINE

SUN ANGEL

BEAUTY ANGEL

Ergoline

TOPSELLER SYSTEM

Dear customer,

Thank you for your interest in our brands. In this price list we offer you equipment in different price ranges, designs and features. In order to help you select your favorite product we have marked "Topseller" equipment in this price list. Topseller are first choice of our customers.

Practical features, high acceptance of customers, best value for money combined with highest resale value distinguishes our products. Topseller versions we generally deliver 2-4 weeks after we receive your order.

Of course we are also happy if you buy a „non Topseller“ version. We are also very happy to produce these units individually for you! Please note, that when you order a “non Topseller” version a 10% prepayment of the list price is due. The delivery time of these products is approx. 4 weeks.

Topseller or not – the entire JK-Team wishes you lots of success with your new equipment.

JK PROFESSIONAL PRICELIST 04/2017

This price list takes effect from 1st April 2017. It will retain validity until a new price list is published. The products offered in this price list are exclusively distributed by JK-International GmbH and their trade partners. The prices quoted are list prices and exclude statutory VAT.

The products indicated in this price list are delivered ex works. Changes in the technical execution and design, price and delivery possibility reserved. All prices for our equipment are excluded time control system.

The products listed must not be exported to or operated in either the USA and Canada JK-International GmbH shall not accept any producer's liability in this case. It is expressly pointed out that any violation of this ban may subject the exporter and/or operator to high risks of liability.

You may obtain all expendable articles, such as bulbs, lamps, starters, Aqua Fresh & Aroma refit kits as well as cleaning and cosmetic products from JK-International GmbH, Koehlershohner Strasse, 53578 Windhagen, Germany, phone +49 2224/818-600.

WARRANTY

JK-International GmbH guarantees the purchaser for a period of 24 months starting from the date of delivery that the goods are free from defects which would ruin or reduce their value or usual merchantability. High-pressure lamps, low-pressure lamps and starters as well as base acrylics are components that are subject to a process of natural wear. Defect-related claims on part of the purchaser shall be ruled out if the product defect is the result of wear.

QUALITY PAYS – 10 GOOD REASONS FOR ERGOLINE

When dealing with the sun quality is paying off. The factors of success can be easily combined: Excellent products, excellent service, an excellent business concept and especially well-known brand names. Ergoline gives you that competitive edge. But don't take our word for it, compare Ergoline with the rest; you don't want to settle for less.

EXCELLENT BRAND NAME

Ergoline is by far the world's most popular sunbed brand name amongst salon owners and customers alike. There are good reasons for that. Deciding for a professional sunbed from the worldwide market leader means setting the scenes for success in the tanning business. You benefit not only from our product's reliability and long service life in the endurance test that is everyday salon operation, but also the low depreciation on all our models when it comes to selling your used Ergoline sunbed.

APPROVED SAFETY

Ergoline keeps you on the safe side. Our models carry the German TÜV seal and GS "tested safety" kitemark, and naturally the statutory CE label. All components that need to be accessible for maintenance and servicing are easy to reach, and are equipped with multiple backup safety features with an intelligent protection system, switching off automatically if a malfunction is detected.

GUARANTEED QUALITY

All components we use in our sunbed production are made of high-quality materials, which are all tested for resistance against UV light, cleaning fluids and other potential hazards as well as potential health risks. Our state-of-the-art manufacturing technologies and

qualified staff ensure especially high-quality workmanship. Every Ergoline sunbed undergoes a variety of functional tests before it leaves the factory. We were the first sunbed manufacturer to be certified by TÜV for compliance with the EN ISO 9001 quality standard, confirming our claim to quality.

EXCELLENT SERVICE

If you should experience technical problems with one of your Ergoline sunbeds, we have a complete service network to fix the problem. We guarantee prompt and professional repairs by authorised and qualified service technicians. Our technicians carry a wide range of commonly used spare parts. As an added support, thousands of parts are stored at our state-of-the-art logistics centre.

TRENDSETTING DESIGN

Often, you'll only really appreciate excellent design after years of use. This is why you will not find any superficial trends or gimmicks on our sunbeds. Clear lines, quality surface finishes and fascinating lighting effects will inspire your customers now and in years to come. Furthermore, the LED Light Show provides a fascinating light presentation and many individualisation possibilities. Make your daily studio routine more colourful!

COMFORT SECOND TO NONE

Our ergonomic concepts give you and your customers tanning comfort and convenience that is second to none. Or Climatronic cooled air conditioning for exact tanning temperature adjustment. Aqua Fresh & Aroma will give your customers a particularly refreshing tanning experience. Innovative 3D sound systems give you perfect musical enjoyment.

EASY HANDLING

Every Ergoline sunbed has been designed to ensure that all components that require servicing are easily and quickly to reach. Low-maintenance materials ensure easy cleaning for your salon staff. The Professional Set-up Manager provides an extraordinary sunbed management. Whether you choose the light program, sound settings or adjust air condition and ventilation – all settings perform easier and faster than ever. With the NFC Connect you can transfer the entire configuration to other sunbeds.

INNOVATIVE UV TECHNOLOGIES

Ergoline's innovative UV systems lead the world. The company's in-house Development Centre has regularly launched new cutting-edge technologies to increase tanning power, energy efficiency, and naturally also safety in sunbeds. Our Hybrid Performance technology sets new standards in tanning technology. This unique combination of UV and red light delivers a particularly attractive and long-lasting tan with simultaneous skin care. Another totally new feature is Personal Sunstyle. Every customer can have their personally select their tan at the touch of a button. The maximum output of lamps and facials is adapted to the national regulations.

EXCELLENT SUPPORT FOR YOUR SALON

Ergoline has set standards in professionalising the tanning business with regular training programmes and courses. We also provide high-profile advertising and Point of Sale sales support with high-impact marketing concepts, numerous videos and attractive campaign materials.

PROFESSIONAL SUNBEDS BEAUTY ANGEL

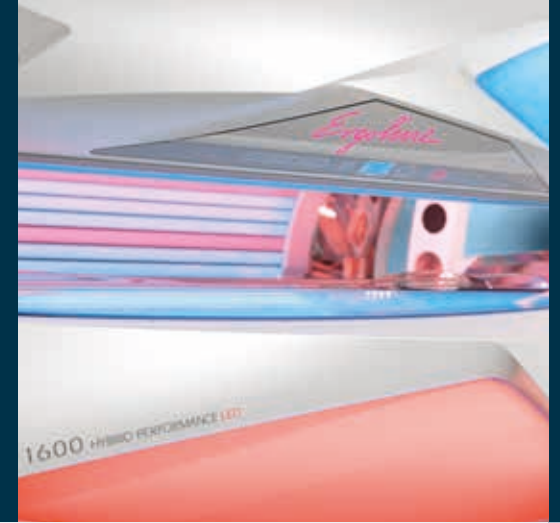

PROFESSIONAL SUNBEDS

AIR DISCHARGE SYSTEM ACCESSORIES



AIR DISCHARGE SYSTEMS | ACCESSORIES

CONTROL SYSTEMS STUDIO EQUIPMENT



CONTROL SYSTEMS | STUDIO EQUIPMENT

ERGOLINE PRESTIGE 1600 HYBRID PERFORMANCE LED

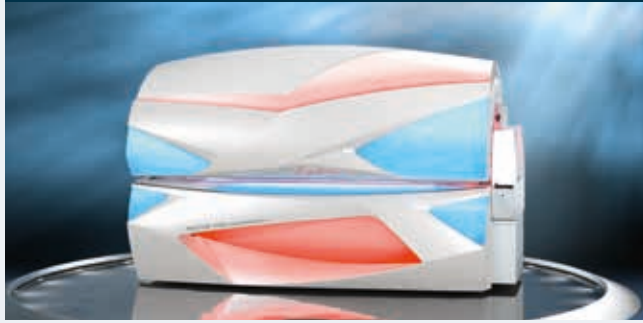

FEATURED AS STANDARD

- Hybrid Performance LED
- Beauty Light LED
- Ultra Performance PLUS
- Shoulder Tan HP
- LED Light Show
- Interior Light
- Personal Sunstyle
- Control Center
- NFC Connect
- Smart Control
- Set-up Manager
- Voice Guide
- Service Light
- Bluetooth
- Aqua Fresh
- Aroma
- Climatronic
- 3D Sound
- MP3 Aux
- ECO Tech
- Multi Relax



DIMENSIONS (in mm)

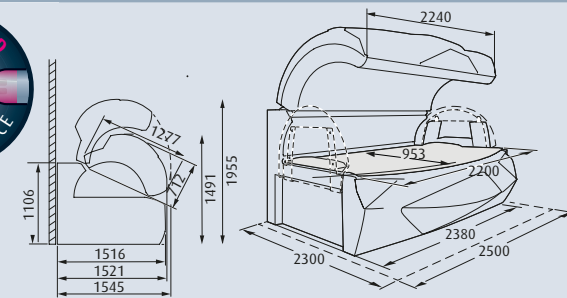

UV	WATTS MAX.	smartsun PLUS	WATTS MAX.	FT	WATTS MAX.
38	200	14	200	4	520

DESIGN SILVERPEARL

	Art. No. EN	Euro, excl. VAT.
Featured as standard	500001281	44,295.-
Featured as standard incl. Climatronic PLUS	500001282	45,295.-



Featured as standard

HYBRID
PERFORMANCE

BEAUTY LIGHT
LED

ULTRA
PERFORMANCE +

2 x 240 W
SHOULDER TAN

PERSONAL
SUNSTYLE

SMART CONTROL

LED LIGHT SHOW

INTERIOR LIGHT

220 x 95 CM
MULTI RELAX

CLIMATRONIC

SERVICE LIGHT

ECO TECH

CONTROL CENTER

NFC CONNECT

SET-UP MANAGER

BLUETOOTH
CONNECT

3D SOUND

MP3 AUX

VOICE GUIDE

Optional at extra costs

CLIMATRONIC PLUS

Lamps: 24 top part/8 side part/20 base part | The power of the facials might be reduced to 420 W due to national regulations (0.3 W/m²).

* 3D-Sound unit includes Voice Guide, MP3- & iPod-Dock-in, SD-Card-Slot Automatic Volume and Auto Play.

ERGOLINE PRESTIGE 1400

INTELLIGENT PERFORMANCE

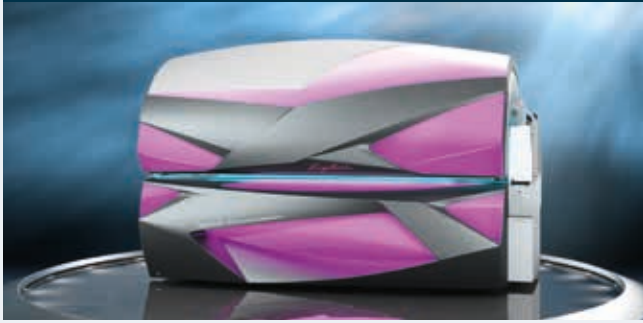

FEATURED AS STANDARD

- Intelligent Performance
- Ultra Performance PLUS
- Shoulder Tan HP
- LED Light Show
- Interior Light
- Multi Relax
- Climatronic PLUS (closed tanning tunnel)
- Comfort Cooling PLUS
- Aqua Fresh
- Aroma
- 3D-Sound-Unit
- MP3 Aux
- Voice Guide
- ECO Tech
- Control Center
- NFC Connect
- Set-up Manager
- Bluetooth
- Service Light



LAMPS	WATTS MAX.	FT	WATTS MAX.	FT SPAGHETTIS
52	200	4	520	3 x 8 W

DIMENSIONS (in mm)

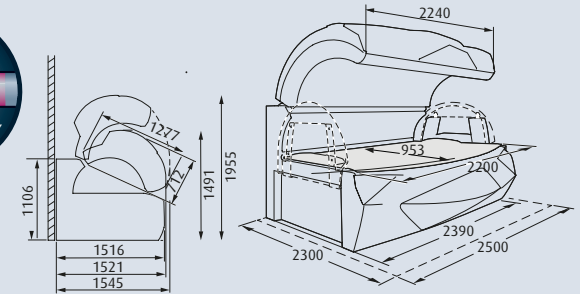

DESIGN CARBON GREY

Art. No. EN

Euro, excl. VAT.

Featured as standard incl. Climatronic PLUS • Aqua Fresh & Aroma • Shoulder Tan HP incl. 3D-Sound-Unit*

500001285

**TOP
SELLER**

42,995.-

Featured as standard

INTELLIGENT 52 x 200 W PERFORMANCE	ULTRA 4 x 520 W 3 x 8 W PERFORMANCE +	2 x 240 W SHOULDER TAN	LED LIGHT SHOW	INTERIOR LIGHT	220 x 95 CM MULTI RELAX	COMFORT COOLING +	CLIMATRONIC PLUS	AQUA FRESH	AROMA
3D SOUND	MP3 AUX	VOICE GUIDE	ECO TECH	CONTROL CENTER	NFC CONNECT	SET-UP MANAGER	BLUETOOTH CONNECT	SERVICE LIGHT	

Lamps: 24 top part/8 side part/20 base part | The power of the facials might be reduced to 420 W due to national regulations (0.3 W/m²).

* 3D-Sound unit includes Voice Guide, MP3- & iPod-Dock-in, SD-Card-Slot Automatic Volume and Auto Play.

ERGOLINE PRESTIGE 1200

INTELLIGENT PERFORMANCE

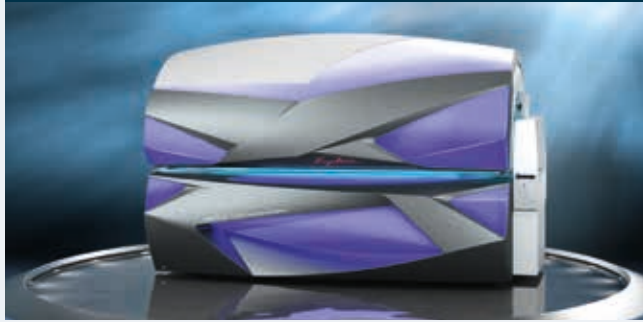

FEATURED AS STANDARD

- Intelligent Performance
- Ultra Performance PLUS
- LED Light Show
- Interior Light
- Multi Relax
- Comfort Cooling PLUS
- Climatronic
- ECO Tech
- Control Center
- NFC Connect
- Set-up Manager
- Service Light



DIMENSIONS (in mm)

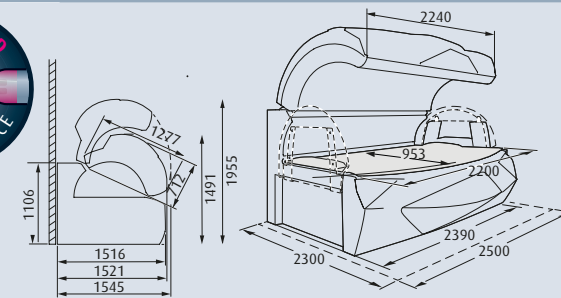

LAMPS	WATTS MAX.	FT	WATTS MAX.	FT SPAGHETTIS
52	200	4	520	3 x 8 W

DESIGN CARBON GREY

Art. No. EN

100003395

Euro, excl. VAT.

TOP
SELLER

37,895.-

Featured as standard incl. Climatronic

Optional extra: Shoulder Tan HP incl. 3D-Sound-Unit* and Bluetooth Connect

100003382

2,995.-

Featured as standard

INTELLIGENT 52 x 200 W PERFORMANCE	ULTRA 4 x 520 W 3 x 8 W PERFORMANCE +	LED LIGHT SHOW	INTERIOR LIGHT	220 x 95 CM MULTI RELAX	COMFORT COOLING +
CLIMATRONIC	ECO TECH	CONTROL CENTER	NFC CONNECT	SET-UP MANAGER	SERVICE LIGHT

Optional at extra costs

2 x 240 W SHOULDER TAN	3D SOUND	BLUETOOTH CONNECT
MP3 AUX	VOICE GUIDE	

Lamps: 24 top part/8 side part/20 base part | The power of the facials might be reduced to 420 W due to national regulations (0.3 W/m²).

* 3D-Sound unit includes Voice Guide, MP3- & iPod-Dock-in, SD-Card-Slot Automatic Volume and Auto Play.

ERGO LINE PRESTIGE 1000

INTELLIGENT PERFORMANCE



FEATURED AS STANDARD

- Intelligent Performance
- Ultra Performance PLUS
- LED Light Show
- Interior Light
- Multi Relax
- Comfort Cooling PLUS
- Climatronic
- ECO Tech
- Control Center
- NFC Connect
- Set-up Manager
- Service Light

Optional

- Aqua Fresh
- Aroma



DIMENSIONS (in mm)

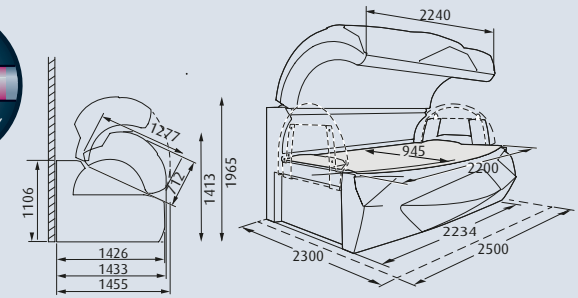

LAMPS	WATTS MAX.	FT	WATTS MAX.	FT SPAGHETTIS
48	200	4	500	3 x 8 W

DESIGN DIAMANT SILVER

Art. No. EN

Euro, excl. VAT.

Featured as standard incl. Climatronic • incl. NFC

100003407

37,295.-

Featured as standard incl. Climatronic • incl. NFC • incl. Aqua Fresh & Aroma

500001292

38,295.-



Optional extra: Shoulder Tan HP incl. 3D-Sound-Unit* and Bluetooth Connect

100003382

2,995.-

Featured as standard

INTELLIGENT 48 x 200 W PERFORMANCE	ULTRA 4 x 500 W 3 x 8 W PERFORMANCE +	LED LIGHT SHOW	INTERIOR LIGHT	220 x 85 CM MULTI RELAX	COMFORT COOLING +	CLIMATRONIC
AQUA FRESH	AROMA	ECO TECH	CONTROL CENTER	NFC CONNECT	SET-UP MANAGER	SERVICE LIGHT

Optional at extra costs

2 x 240 W SHOULDER TAN	3D SOUND	BLUETOOTH CONNECT
MP3 AUX	VOICE GUIDE	

Lamps: 22 top part/8 side part/18 base part | The power of the facials might be reduced to 420 W due to national regulations (0.3 W/m²).

* 3D-Sound unit includes Voice Guide, MP3- & iPod-Dock-in, SD-Card-Slot Automatic Volume and Auto Play.

ERGO LINE AFFINITY 990 SLP HYBRID PERFORMANCE



FEATURED AS STANDARD

- Hybrid Performance
- Smart Light Performance
- LED Light Show
- Interior Light
- Smart Control
- Body Shape
- Comfort Cooling PLUS
- Air Condition PLUS

Optional

- Aqua Fresh
- Aroma



DIMENSIONS (in mm)

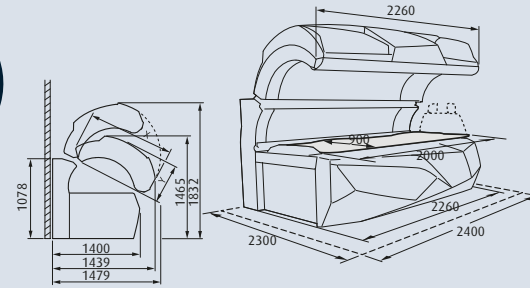

LAMPS	WATTS MAX.	FT	WATTS MAX.	FT SPAGHETTIS
50	180	4	420	3 x 8 W

DESIGN BRILLIANT WHITE

	Artikel-Nr. EN	Euro ohne MwSt.
Featured as standard incl. Air Condition PLUS, dimmable electronic ballasts	100003448	32,795.-
Featured as standard incl. Air Condition PLUS, dimmable electronic ballasts • incl. Aqua Fresh & Aroma	500001327	33,795.-
Optional extra: 3D-Sound-Unit**	100000852	1,010.-
Optional extra: smartsun Shoulder Tan incl. 3D-Sound-Unit**	100003450	2,215.-



Featured as standard

HYBRID 14x 180 W 36x 180 W PERFORMANCE	SMART LIGHT PERFORMANCE	LED LIGHT SHOW	INTERIOR LIGHT	SMART CONTROL
BODY SHAPE	COMFORT COOLING +	AIR CONDITION +	AQUA FRESH	AROMA

Optional at extra costs

SMARTSUN 7x 25 W SHOULDER TAN	3D SOUND
MP3 AUX	VOICE GUIDE

Lampes: 24 top part/8 side part/18 base part | The power of the facials might be reduced to 420 W due to national regulations (0.3 W/m²).

* You receive two additional sets of lamps with low-pressure UV lamps and high-pressure facials incl. spaghetti lamps.

** 3D-Sound unit includes Voice Guide, MP3- & iPod-Dock-in, SD-Card-Slot Automatic Volume and Auto Play.

ERGO LINE AFFINITY 990

DYNAMIC PERFORMANCE

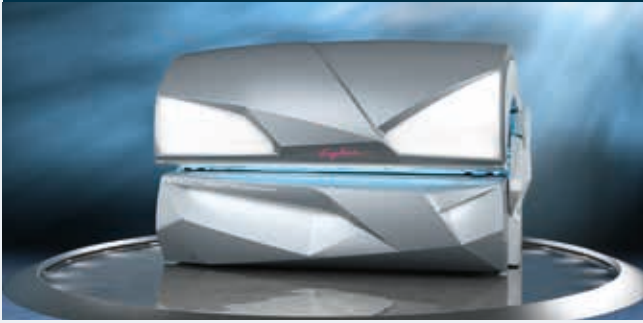

FEATURED AS STANDARD

- Dynamic Performance
- Ultra Performance PLUS
- LED Light Show
- Interior Light
- Smart Control
- Body Shape
- Comfort Cooling PLUS
- Air Condition PLUS

Optional

- Aqua Fresh
- Aroma



LAMPS	WATTS MAX.	FT	WATTS MAX.	FT SPAGHETTIS
50	180	4	520	3 x 8 W

DIMENSIONS (in mm)

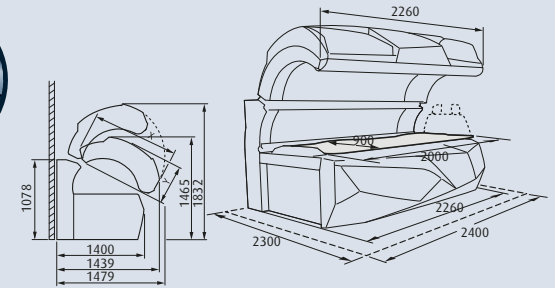

DESIGN PLATINUM GREY

	Art. No. EN	Euro, excl. VAT.
Featured as standard incl. Air Condition PLUS	100003281	31,795.-
Featured as standard incl. Air Condition PLUS • incl. Aqua Fresh & Aroma	500001211	32,795.-
Optional extra: Shoulder Tan	100003297	1,175.-
Optional extra: 3D-Sound-Unit**	100000852	1,010.-
Optional extra: Shoulder Tan inkl. 3D-Sound-Unit**	100003298	2,115.-



Featured as standard

DYNAMIC 50 x 180 W PERFORMANCE	ULTRA 4 x 520 W 3 x 8 W PERFORMANCE +	LED LIGHT SHOW	INTERIOR LIGHT	SMART CONTROL
208 x 90 CM BODY SHAPE	COMFORT COOLING +	AIR CONDITION +	AQUA FRESH	AROMA

Optional at extra costs

7 x 25 W SHOULDER TAN	3D SOUND	MP3 AUX
VOICE GUIDE		

Lamps: 24 top part/8 side part/18 base part | The power of the facials might be reduced to 420 W due to national regulations (0.3 W/m²).

* You receive two additional sets of lamps with low-pressure UV lamps and high-pressure facials incl. spaghetti lamps.

** 3D-Sound unit includes Voice Guide, MP3- & iPod-Dock-in, SD-Card-Slot Automatic Volume and Auto Play.

ERGO LINE AFFINITY 900 ADVANCED PERFORMANCE

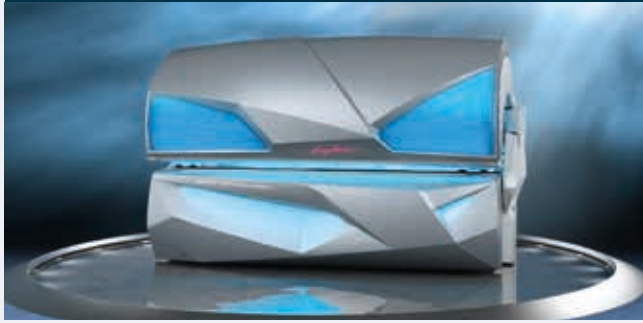

FEATURED AS STANDARD

- Advanced Performance
- Ultra Performance PLUS
- LED Light Show
- Interior Light
- Smart Control
- Body Shape
- Comfort Cooling PLUS
- Air Condition PLUS



DIMENSIONS (in mm)

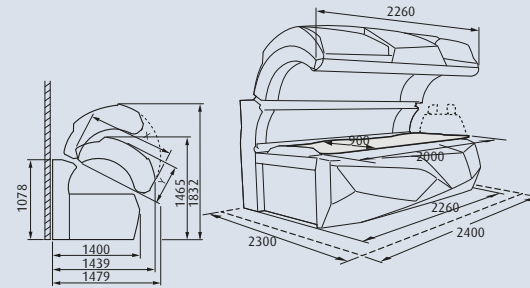

LAMPS	WATTS MAX.	FT	WATTS MAX.	FT SPAGHETTIS
50	160	4	520	3 x 8 W

DESIGN PLATINUM GREY

Featured as standard Turbo Power incl. Air Condition PLUS

INCLUDING
2 ADDITIONAL
SETS OF LAMPS*

Art. No. EN

100003265

TOP
SELLER

Euro, excl. VAT.

27,875.-

Optional extra: Shoulder Tan

100003297

1,175.-

Optional extra: 3D-Sound-Unit**

100000852

1,010.-

Optional extra: Shoulder Tan inkl. 3D-Sound-Unit**

100003298

2,115.-

Featured as standard

ADVANCED TURBO POWER 50 x 160 W PERFORMANCE	ULTRA 4 x 520 W 3 x 8 W PERFORMANCE +	 LED LIGHT SHOW	 INTERIOR LIGHT
 SMART CONTROL	 208 x 90 CM BODY SHAPE	 COMFORT COOLING +	 AIR CONDITION +

Optional at extra costs

 7 x 25 W SHOULDER TAN	 3D SOUND	 MP3 AUX
 VOICE GUIDE		

Lamps: 24 top part/8 side part/18 base part | The power of the facials might be reduced to 420 W due to national regulations (0.3 W/m²).

* You receive two additional sets of lamps with low-pressure UV lamps and high-pressure facials incl. spaghetti lamps.

** 3D-Sound unit includes Voice Guide, MP3- & iPod-Dock-in, SD-Card-Slot Automatic Volume and Auto Play.

ERGO LINE AFFINITY 700 ADVANCED PERFORMANCE

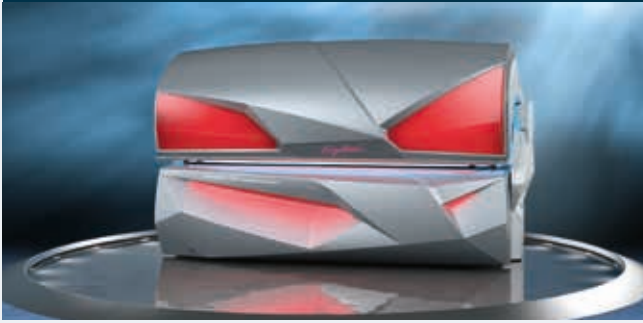

FEATURED AS STANDARD

- Advanced Performance
- Ultra Performance PLUS
- LED Light Show
- Interior Light
- Smart Control
- Body Shape
- Comfort Cooling PLUS

- Optional**
- Air Condition PLUS (only Turbo Power)



LAMPS	WATTS MAX.	FT	WATTS MAX.	FT SPAGHETTIS
46	160	3	500	2x 8 W

DIMENSIONS (in mm)

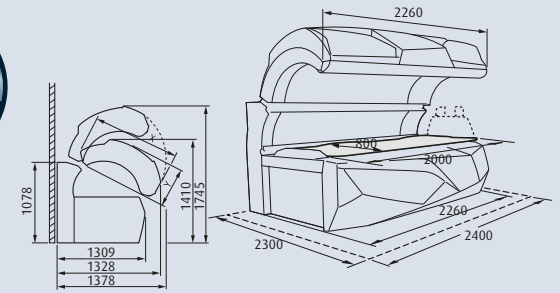

DESIGN PLATINUM GREY

	Art. No. EN	Euro, excl. VAT.
Featured as standard Twin Power (28 Lamps à 160 W / 18 Lamps à 120 W)	100003266	21,495.-
Featured as standard Twin Power (28 Lamps à 160 W / 18 Lamps à 120 W), incl. intermediate acrylic	100003335	22,095.-
Featured as standard Turbo Power incl. Air Condition PLUS (46 Lamps à 160 W)	100003322	25,595.-
Optional extra: Shoulder Tan	100003297	1,175.-
Optional extra: 3D-Sound-Unit**	100000852	1,010.-
Optional extra: Shoulder Tan inkl. 3D-Sound-Unit**	100003298	2,115.-

INCLUDING 2 ADDITIONAL SETS OF LAMPS*

TOP SELLER

Featured as standard

ADVANCED TWIN POWER 28 x 160 W 18 x 120 W PERFORMANCE	ADVANCED TURBO POWER 46 x 160 W PERFORMANCE	ULTRA 3x 500 W 2x 8 W PERFORMANCE +	LED LIGHT SHOW	INTERIOR LIGHT
SMART CONTROL	BODY SHAPE 208 x 80 CM	COMFORT COOLING +	AIR CONDITION +	

Optional at extra costs

7 x 25 W SHOULDER TAN	3D SOUND	MP3 AUX
VOICE GUIDE		

Lamps: 20 top part/8 side part/18 base part | The power of the facials might be reduced to 420 W due to national regulations (0.3 W/m²).

* You receive two additional sets of lamps with low-pressure UV lamps and high-pressure facials incl. spaghetti lamps.

** 3D-Sound unit includes Voice Guide, MP3- & iPod-Dock-in, SD-Card-Slot Automatic Volume and Auto Play.

ERGOLINE INSPIRATION 600

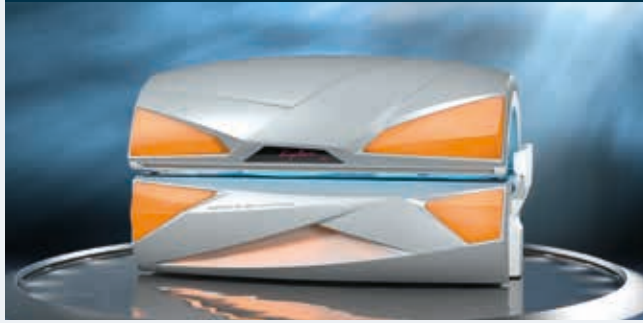

FEATURED AS STANDARD

- Ultra Performance PLUS
- LED Light Show
- Interior Light
- Bodyform PLUS
- Comfort Cooling PLUS
- NFC Connect

Optional

- Air Condition PLUS
- Aqua Fresh
- Aroma



DIMENSIONS (in mm)

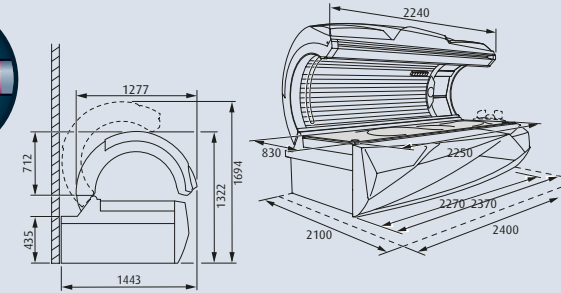

LAMPEN	GB	WATT MAX.	GB SPAGHETTIS
42	4	400	3 x 8 W

DESIGN SATIN SILVER

Art. No. EN

Euro, excl. VAT.

Featured as standard Smart Performance, Twin Power [26 Lampen à 140 (160) W/16 Lampen à 120 (140) W]* incl. NFC

100003169

20,495.-

Featured as standard Dynamic Performance (42 Lamp. à 80 - 200 W) incl. AC PLUS • incl. Aqua Fresh & Aroma • incl. NFC

500001148

25,595.-

* Watt Input (Output)



Optional extra: 3D-Sound-Unit**

100003217

1,010.-

Featured as standard

<p>DYNAMIC PERFORMANCE</p>	<p>SMART TWIN POWER PERFORMANCE</p>	<p>ULTRA PERFORMANCE +</p>	<p>LED LIGHT SHOW</p>	<p>INTERIOR LIGHT</p>	<p>BODYFORM PLUS</p>
<p>COMFORT COOLING +</p>	<p>AIR CONDITION +</p>	<p>AQUA FRESH</p>	<p>AROMA</p>	<p>NFC CONNECT</p>	

Optional at extra costs

<p>3D SOUND</p>	<p>MP3 AUX</p>
<p>VOICE GUIDE</p>	

Lamps: 26 top part (1,80 m)/16 base part (2,00 m)

** 3D-Sound unit includes Voice Guide, MP3- & iPod-Dock-in, SD-Card-Slot Automatic Volume and Auto Play.

ERGO LINE INSPIRATION 500 SLP

HYBRID PERFORMANCE



FEATURED AS STANDARD

- Hybrid Performance
- Smart Light Performance
- LED Mood Light
- Interior Light
- Bodyform PLUS
- Comfort Cooling PLUS

DIMENSIONS (in mm)

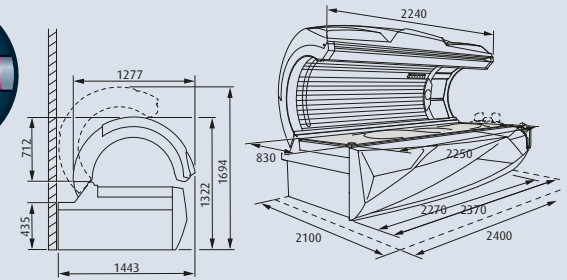

LAMPS	FT	WATTS MAX.	FT SPAGHETTIS
38	3	400	2 x 8 W

DESIGN BRILLIANT WHITE

Art. No. EN

Euro, excl. VAT.

Featured as standard Hybrid Performance, Twin Power [24 Lamps à 140 (160) W/14 Lamps à 120 (140) W]*, static electronic ballasts

100003447



18,295.-

* Watt Input (Output)

Optional extra: 3D-Sound-Unit**

100003217

1,010.-

Featured as standard

<p>HYBRID</p> <p>12x 160/140 W</p> <p>26x 160/140 W</p> <p>PERFORMANCE</p>	<p>SMART LIGHT</p> <p>PERFORMANCE</p>	<p>LED MOOD LIGHT</p>	<p>INTERIOR LIGHT</p>
<p>225 x 82 CM</p> <p>BODYFORM PLUS</p>	<p>COMFORT COOLING +</p>		

Lamps: 24 top part (1,80 m)/14 base part (2,00 m)

Optional at extra costs

<p>3D SOUND</p>	<p>MP3 AUX</p>
<p>VOICE GUIDE</p>	

ERGOLINE INSPIRATION 500 SMART PERFORMANCE



FEATURED AS STANDARD

- Ultra Performance PLUS
- LED Light Show
- Interior Light
- Bodyform PLUS
- Comfort Cooling PLUS

Optional (only Turbo Power)

- Air Condition PLUS



DIMENSIONS (in mm)

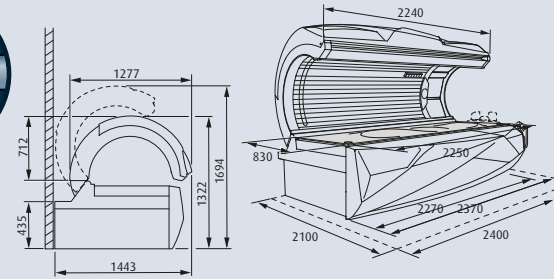

LAMPS	FT	WATTS MAX.	FT SPAGHETTIS
38	3	400	2 x 8 W

DESIGN SATIN SILVER

	Art. No. EN		Euro, excl. VAT.
Featured as standard Smart Performance, Super Power [24 Lamps à 100 (120) W/14 Lamps à 120 (140) W]*	100003154	TOP SELLER	16,295.-
Featured as standard Smart Performance, Twin Power [24 Lamps à 140 (160) W/14 Lamps à 120 (140) W]*	100003166		17,795.-
Featured as standard Smart Performance, Turbo Power [38 Lamps à 140 (160 W)]* incl. Air Condition PLUS	100003198	TOP SELLER	19,695.-
Optional extra: 3D-Sound-Unit**	100003217		1,010.-

* Watt Input (Output)

Featured as standard

SMART
TURBO POWER
24x 160 W
14x 180 W
PERFORMANCE

SMART
TWIN POWER
24x 160 W
14x 140 W
PERFORMANCE

SMART
SUPER POWER
24x 120 W
14x 140 W
PERFORMANCE

ULTRA
3 x 400 W
2 x 8 W
PERFORMANCE +

LED LIGHT SHOW

INTERIOR LIGHT

BODYFORM PLUS
225 x 82 CM

COMFORT COOLING +

AIR CONDITION +

Optional at extra costs

3D SOUND

MP3 AUX

VOICE GUIDE

Lamps: 24 top part (1,80 m)/14 base part (2,00 m)

** 3D-Sound unit includes Voice Guide, MP3- & iPod-Dock-in, SD-Card-Slot Automatic Volume and Auto Play.

ERGO LINE INSPIRATION 400



FEATURED AS STANDARD

- Advanced Performance
- Ultra Performance PLUS
- Interior Light
- Bodyform PLUS
- Comfort Cooling
- Mood Light



DIMENSIONS (in mm)

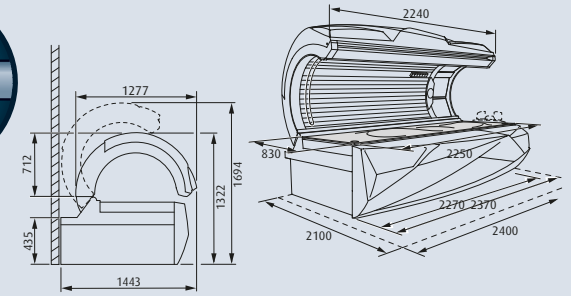

LAMPS	FT	WATTS	FT SPAGHETTIS
38	3	400	2x 8 W

DESIGN BRILLIANT WHITE

Art. No. EN

Euro, excl. VAT

SFeatured as standard Advanced Performance, Super Power [24 Lamps à 100 W/14 Lamps à 120 W]*

100003327

14,295.-

Optional extra: 3D-Sound-Unit**

100001531

1,010.-

Add-on kit Inspiration: Intermediate acrylic without fan

100001854

347.-

Featured as standard

<p>ADVANCED SUPER POWER</p> <p>24x 100 W 14x 120 W</p> <p>PERFORMANCE</p>	<p>ULTRA</p> <p>3 x 400 W 2 x 8 W</p> <p>PERFORMANCE +</p>	<p>INTERIOR LIGHT</p>
<p>225 x 82 CM</p> <p>BODYFORM PLUS</p>	<p>COMFORT COOLING</p>	<p>MOOD LIGHT</p>

Lamps: 24 top part (1,80 m)/14 base part (2,00 m)

Optional at extra costs

<p>3D SOUND</p>	<p>MP3 AUX</p>
<p>VOICE GUIDE</p>	

ERGOLINE PASSION 300-S
ERGOLINE PASSION 350-S



DIMENSIONS (in mm)

- Ultra Performance PLUS
- Mood Light Techno Yellow (Passion 300-S)
- Photo Art People Single (Passion 350-S)
- Bodyform PLUS
- Comfort Cooling
- Time Control



DIMENSIONS (in mm)

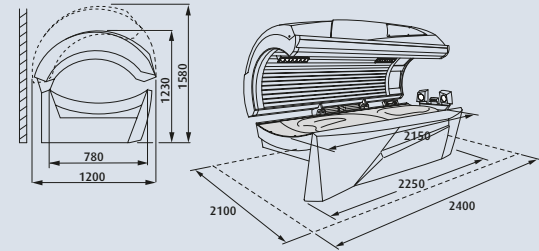

FT WATTS MAX. FT SPAGHETTIS

3 **400** **2 x 8 W**

DESIGN BRILLIANT WHITE

	Art. No. EN	Euro, excl. VAT
Featured as standard 300-S Super Power Mood Light Techno Yellow (34 Lamps à 100 W)	500000760	9,195.-
Featured as standard 300-S Twin Power Mood Light Techno Yellow (18 Lamps à 140 W/16 Lamps à 100 W)	500000764	9,795.-
Featured as standard 350-S Super Power Photo Art People Single (38 Lamps à 100 W)	500000769	10,795.-
Featured as standard 350-S Turbo Power Photo Art People Single (38 Lamps à 140 W)	500000777	11,795.-
Optional extra: Stereo Sound	100002315	355.-
Optional extra: Stereo Sound PLUS*	100002312	710.-
Optional extra: Side cover Passion (one-piece)	100002314	102.-



Featured as standard

SUPER

34x 100 W

POWER

TWIN

18x 140 W
16x 100 W

POWER

SUPER

38x 100 W

POWER

TURBO

38 x 140 W

POWER

ULTRA

3x 400W
2x 8 W

PERFORMANCE+

MOOD LIGHT

PHOTO ART

215 x 78 CM

BODYFORM PLUS

COMFORT COOLING

12:00

TIME CONTROL

Optional at extra costs

STEREO SOUND

STEREO SOUND +

Lamps Ergoline Passion 300-S: 18 top part (1,80 m)/16 base part (2,00 m) | Lamps Ergoline Passion 350-S: 22 top part (1,80 m)/16 base part (2,00 m)

* Stereo Sound PLUS includes external audio connection, amplifier, headset and MP3-connect and Auto Play.

ERGO LINE FLAIR 250 SUPER POWER

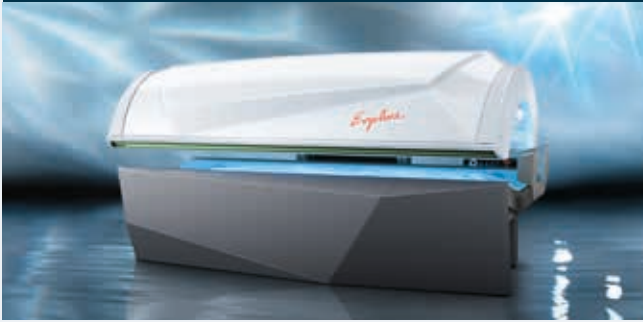

FEATURED AS STANDARD

- Super Power
- Ultra Performance
- Bodyform PLUS
- Comfort Cooling
- Time Control

LAMPS	WATTS	FT	WATTS
30	100	3	400

DIMENSIONS (in mm)

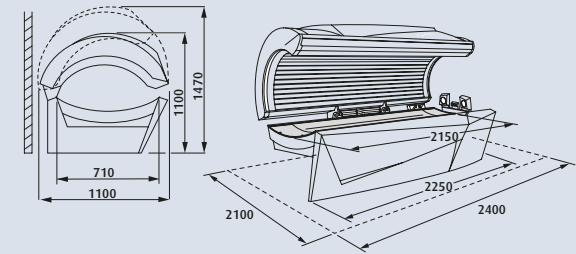

DESIGN BRILLIANT WHITE ANTHRACITE

Featured as standard incl. PROFILE-Design Shining Green

Art. No. EN

100002070



Euro, excl. VAT

7,495.-

Optional extra: PROFILE-Design Anthracite

100002370

70.-

Optional extra: Stereo Sound

100002315

355.-

Optional extra: Stereo Sound PLUS*

100002312

710.-

Optional extra: Side cover Passion (one-piece)

100002313

102.-

Featured as standard

<p>SUPER</p> <p>30 x 100 W</p> <p>POWER</p>	<p>ULTRA</p> <p>3 x 400 W</p> <p>PERFORMANCE</p>	<p>215 x 71 CM</p> <p>BODYFORM PLUS</p>
<p>COMFORT COOLING</p>	<p>12:00</p> <p>TIME CONTROL</p>	

Optional at extra costs

<p>STEREO SOUND</p>	<p>STEREO SOUND +</p>
---------------------	-----------------------

Lamps: 18 top part (1,80 m)/12 base part (2,00 m)

* Stereo Sound PLUS includes external audio connection, amplifier, headset and MP3-connect and Auto Play.

ERGO LINE FLAIR 200 SUPER POWER



FEATURED AS STANDARD

- Super Power
- Ultra Performance
- Bodyform PLUS
- Comfort Cooling
- Time Control
- 230 V connection

LAMPS	WATTS	FT	WATTS
27	100	1	300

DIMENSIONS (in mm)

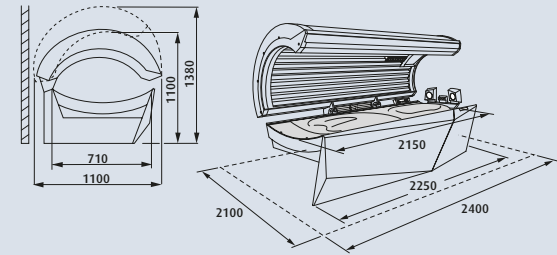

DESIGN SOFT GREY SILVER

Featured as standard incl. PROFILE-Design Anthracite

Art. No. EN

100001899



Euro, excl. VAT

5,995.-

Optional extra: PROFILE-Design Shining Green

100002369

70.-

Optional extra: Stereo Sound

100002315

355.-

Optional extra: Stereo Sound PLUS*

100002312

710.-

Optional extra: Side cover Passion (one-piece)

100002313

102.-

Featured as standard

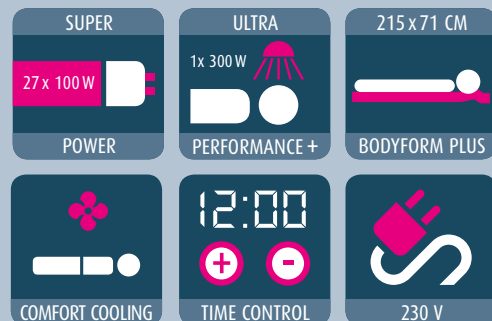

Lamps: 16 top part (1,80 m)/11 base part (2,00 m)

Optional at extra costs

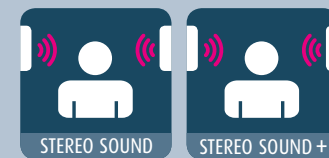

* Stereo Sound PLUS includes external audio connection, amplifier, headset and MP3-connect and Auto Play.

ERGO LINE SUNRISE 480 LED
ERGO LINE SUNRISE 488 LED



FEATURED AS STANDARD

- Dynamic Performance / Advanced Performance (Turbo Power)
- LED Light Show
- LED Interior Light
- Silent Cooling
- Body Space

LAMPS	WATTS MAX.	LAMPS	WATTS
48	200	48	180

DIMENSIONS (in mm)

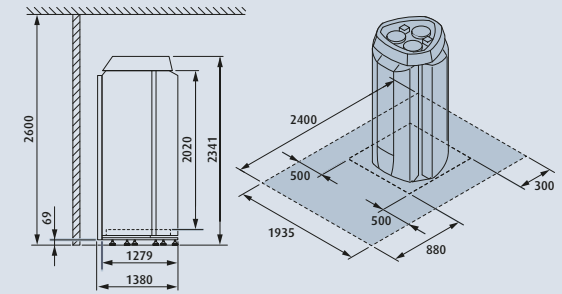

LED DESIGN

	Art. No. EN	Euro, excl. VAT.
Featured as standard Sunrise 480 LED Advanced Performance (Turbo Power)	100003329	14,195.-
Featured as standard Sunrise 488 LED Dynamic Performance	100003330	17,395.-
Optional extra: Aqua Fresh & Aroma	500000463	2,090.-
Optional extra: 3D-Sound-Unit*	100001841	1,010.-
Optional extra: Vibra Shape	100001843	4,475.-

Please note: An adaptor is necessary to connect MCS controls - see page 35!

Featured as standard

<p>DYNAMIC</p> <p>48 x 200 W</p> <p>PERFORMANCE</p>	<p>ADVANCED</p> <p>TURBO POWER</p> <p>48 x 180 W</p> <p>PERFORMANCE</p>	<p>LED LIGHT SHOW</p>	<p>SILENT COOLING</p>
<p>BODY SPACE</p> <p>86 CM</p> <p>208 CM</p>	<p>LED INTERIOR LIGHT</p>		

Optional at extra costs

<p>AQUA FRESH</p>	<p>AROMA</p>	<p>3D SOUND</p>
<p>MP3 AUX</p>	<p>VOICE GUIDE</p>	<p>VIBRA SHAPE</p>

* 3D-Sound unit includes Voice Guide, MP3- & iPod-Dock-in, SD-Card-Slot Automatic Volume and Auto Play.

ERGO LINE SUNRISE 480
ERGO LINE SUNRISE 488



FEATURED AS STANDARD

- Dynamic Performance / Advanced Performance (Turbo Power)
- Interior Light
- Silent Cooling
- Body Space

LAMPS	WATTS MAX.	LAMPS	WATTS
48	200	48	180

DIMENSIONS (in mm)

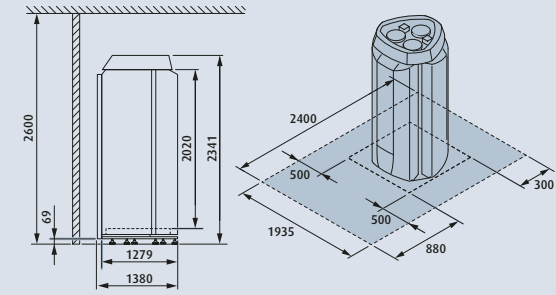

DESIGN BRIGHT WHITE

	Art. No. EN	Euro, excl. VAT.
Featured as standard Sunrise 480 Advanced Performance (Turbo Power)	500000451	12,995.-
Featured as standard Sunrise 488 Dynamic Performance	500000403	16,395.-
Optional extra: Aqua Fresh & Aroma	500000463	2,090.-
Optional extra: 3D-Sound-Unit*	100001841	1,010.-
Optional extra: Vibra Shape	100001843	4,475.-



Please note: An adaptor is necessary to connect MCS controls - see page 35!

Featured as standard

DYNAMIC
48 x 200 W
PERFORMANCE

ADVANCED
TURBO POWER
48 x 180 W
PERFORMANCE

INTERIOR LIGHT

SILENT COOLING

BODY SPACE

Optional at extra costs

AQUA FRESH

AROMA

3D SOUND

MP3 AUX

VOICE GUIDE

VIBRA SHAPE

* 3D-Sound unit includes Voice Guide, MP3- & iPod-Dock-in, SD-Card-Slot Automatic Volume and Auto Play.

ERGO LINE ESSENCE 440

SMART POWER



FEATURED AS STANDARD

- Smart Power
- Top Cooling
- Body Space
- Single Sound
- Time Control

LAMPS WATTS INPUT (OUTPUT)

44 (2m)

180 (200)

DIMENSIONS (in mm)

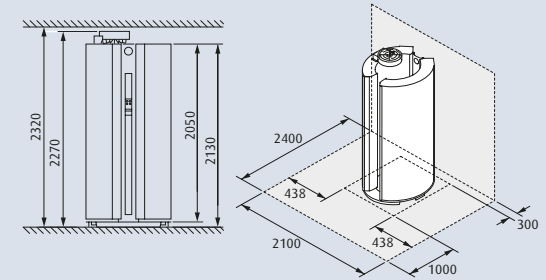

Art. No. EN

Euro, excl. VAT.

Featured as standard Scarlet Red incl. Standby Lighting

100002594



9,995.-

Optional extra: Sound Module*

100002544

400.-

Optional extra: Aroma

100002619

100.-

Optional extra: Connecting wiring 3 x 230V without neutral wire**

1508181-00

53.50

Featured as standard

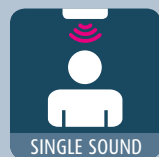
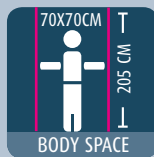
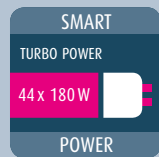

Optional at extra costs

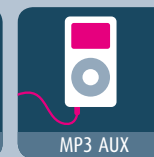
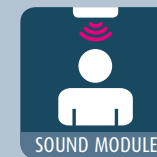

ERGO LINE BALANCE 700
ERGO LINE BALANCE 770



FEATURED AS STANDARD

- Hybrid Performance
- Electronic ballasts
- Beauty Select (Balance 770)
- LED Light Show
- Interior Light
- Smart Control
- Frosted Acrylic
- Comfort Cooling PLUS
- Climatronic (Balance 770)

DIMENSIONS (in mm)

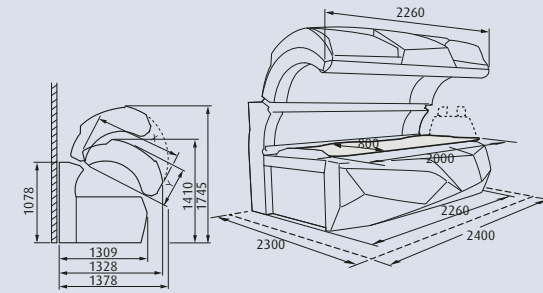

UV	WATTS	BEAUTY LIGHT	WATTS
32	180/160	14	180/160

DESIGN BRILLIANT WHITE

Featured as standard Balance 700

Featured as standard Balance 770 incl. Climatronic

Art. No. EN

Euro, excl. VAT.

**INCLUDING
2 ADDITIONAL
SETS OF LAMPS***

100003275

100003274

**TOP
SELLER**

22,395.-

25,895.-

Optional extra: 3D-Sound-Unit**

100003074

1,010.-

Featured as standard

 HYBRID 32 x 180/160 W 14 x 180/160 W PERFORMANCE	 PURE BEAUTY BEAUTY & SUN SUN & BEAUTY BEAUTY SELECT	 LED LIGHT SHOW	 INTERIOR LIGHT
 SMART CONTROL	 200 x 80 CM FROSTED ACRYLIC	 COMFORT COOLING +	 CLIMATRONIC

Optional at extra costs

 3D SOUND	 MP3 AUX	 VOICE GUIDE
--------------	-------------	-----------------

UV lamps: 20 top part/side part (180 W - 2,00m)
12 base part (160 W - 1,80m)

Beauty Light: 8 top part/side part (180 W - 2,00m)
6 base part (160 W - 1,80m)

* You receive two additional sets of lamps with UV lamps and Beauty Light lamps.

** 3D-Sound unit includes Voice Guide, MP3- & iPod-Dock-in, SD-Card-Slot Automatic Volume and Auto Play.

SUN ANGEL DUO 1400 INDIVIDUAL PERFORMANCE

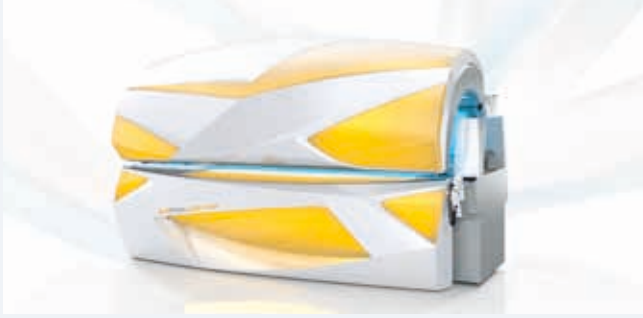

FEATURED AS STANDARD

- Sensor
- Duo Select
- Individual Performance
- Ultra Performance PLUS
- Shoulder Tan
- LED Light Show
- Interior Light
- Multi Relax
- Comfort Cooling
- Climatronic
- Aqua Fresh
- Aroma
- NFC Connect
- Control Center
- 3D-Sound-Unit
- Bluetooth

LAMPS	WATTS MAX.	FT	WATTS MAX.	FT SPAGHETTIS
52	200	4	520	3 x 8 W

DIMENSIONS (in mm)

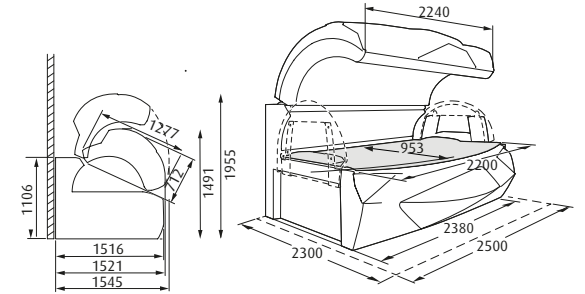

DESIGN HEAVENLY WHITE

Art. No. EN

Euro, excl. VAT.

Featured as standard incl. Climatronic PLUS

50001298

45,095.-

Featured as standard



Lamps: 24 top part/8 side part/20 base part | The power of the facials might be reduced to 420 W due to national regulations (0.3 W/m²).

* 3D-Sound unit includes Voice Guide, MP3- & iPod-Dock-in, SD-Card-Slot Automatic Volume and Auto Play.

BEAUTY ANGEL C 28

FEATURED AS STANDARD

- Beauty Light
- Beauty Design
- Body Form Plus
- Comfort Cooling
- 230 connection
- Time Control

DIMENSIONS (in mm)

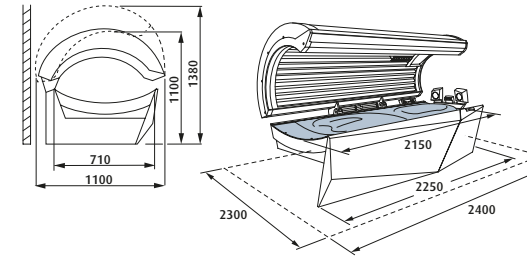

LAMPS

WATTS INPUT (OUTPUT)

28

100

DESIGN BRILLIANT WHITE

Art. No. EN

Euro, excl. VAT.

Featured as standard [28 lamps à 100 W]

100002455

7,695.-

Optional extra: Stereo Sound

100002315

355.-

Optional extra: Stereo Sound Plus*

100002312

710.-

Optional extra: Side cover

100002313

102.-

Featured as standard



Optional at extra costs

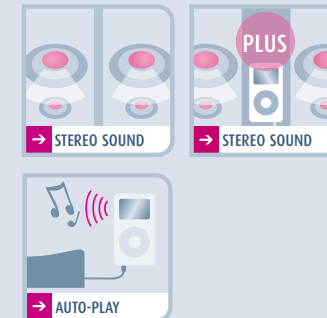

* Stereo Sound Plus includes external audio connection, amplifier, headset and MP3-connect and Auto Play.

BEAUTY ANGEL CVT 32



FEATURED AS STANDARD

- Beauty Light
- Beauty Design
- Standby Lighting
- Body Space
- Single Sound
- Time Control
- Vibra Shape

LAMPS WATTS INPUT (OUTPUT)

32 (2m)

200

DIMENSIONS (in mm)

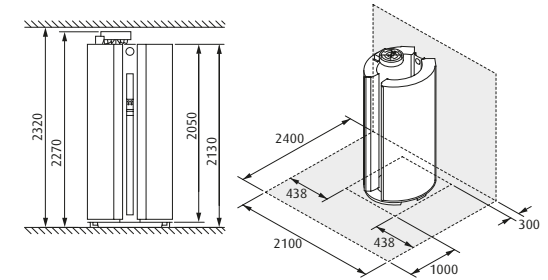

DESIGN BRILLIANT WHITE

Art. No. EN

Euro, excl. VAT.

Featured as standard [32 lamps à 200 W]

500001090

15,195.-

Optional extra: Top Cooling

100002543

400.-

Optional extra: Aroma

100002642

100.-

Optional extra: Sound Module*

100002544

400.-

Optional extra: Connecting wiring 3 x 230V without neutral wire**

1508181-00

53.50

Featured as standard



Optional at extra costs

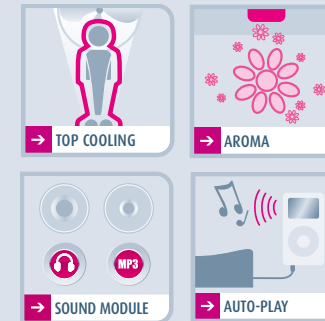

PROFESSIONAL SUNBEDS
HYBRID UNITS
BEAUTY ANGEL

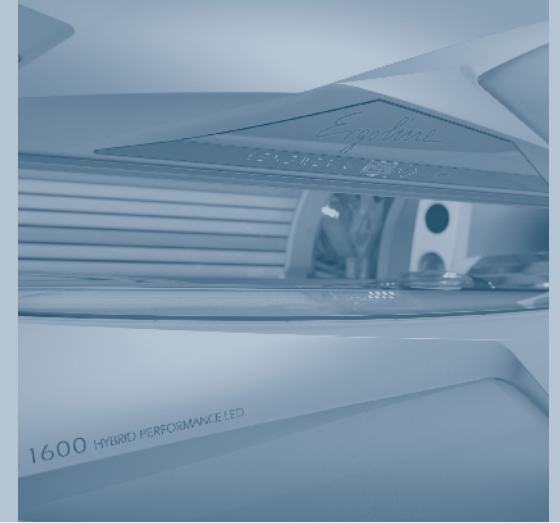

PROFESSIONAL SUNBEDS | HYBRID UNITS

AIR DISCHARGE SYSTEMS
ACCESSORIES



AIR DISCHARGE SYSTEMS | ACCESSORIES

CONTROL SYSTEMS
STUDIO EQUIPMENT



CONTROL SYSTEMS | STUDIO EQUIPMENT

ERGOLINE PRESTIGE
SUN ANGEL DUO 1400

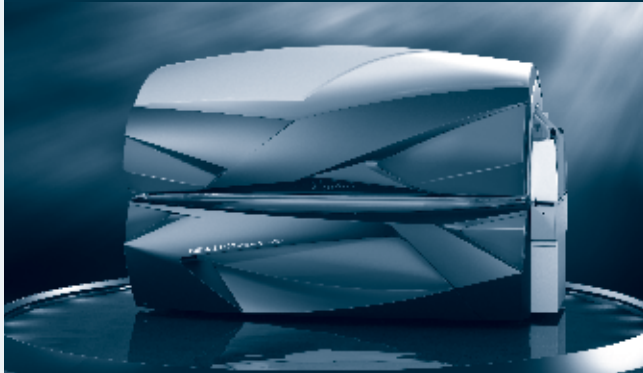

DIMENSIONS ERGOLINE PRESTIGE (in mm)

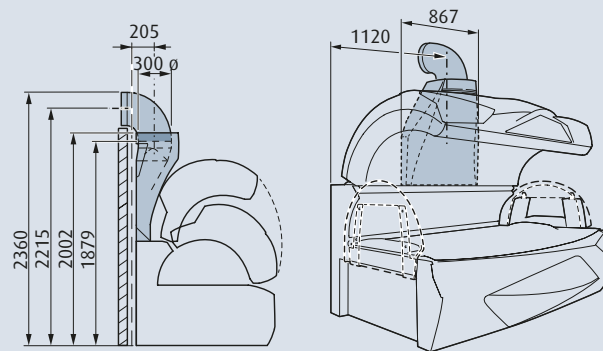

	Art. No. with warm air recovery	Euro, excl. VAT	Art. No. without warm air recovery	Euro, excl. VAT.
Central air discharge socket in Brilliant Silver with direct connection possibility (300 mm Ø) upwards. Channelling the air to the right, to the left or to the rear requires additional use of the curved profile (Art. No. 100001292).	500000872	795.-	500000873	655.-
90° curved profile in Brilliant Silver for routing the air discharge hose to the right, left or rear, including pipe adapter for direct connection to the central air discharge socket. Air ducting possible via direct 300 mm Ø air discharge hose connection.	100001292	158.-	100001292	158.-
Connection socket for 300 mm Ø air discharge hose	34503600	19.-	34503600	19.-
Air discharge hose 300 mm Ø, flexible, grey, 6 m, with 2 hose clips	34502800	107.-	34502800	107.-
Air discharge hose connector 300 mm Ø	34502700	26.-	34502700	26.-
Air discharge assembly for connecting to double rear pane	34526600	82.-	34526600	82.-

ERGOLINE AFFINITY
ERGOLINE BALANCE

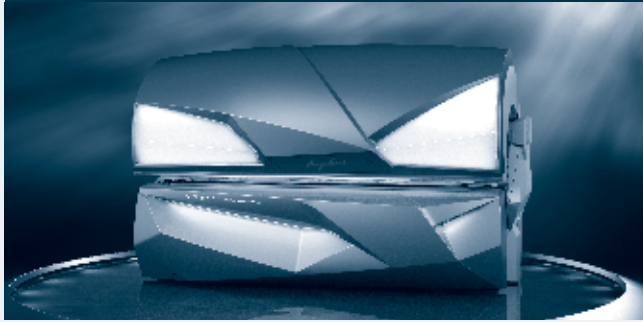

DIMENSIONS ERGOLINE AFFINITY/BALANCE (in mm)

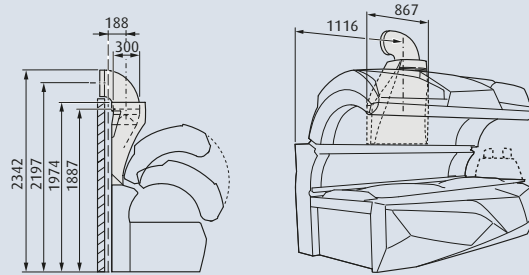

Art. No. with warm air recovery	Euro, excl. VAT	Art. No. without warm air recovery	Euro, excl. VAT.
50000872	795.-	50000873	655.-
100001292	158.-	100001292	158.-
34503600	19.-	34503600	19.-
34502800	107.-	34502800	107.-
34502700	26.-	34502700	26.-
34526600	82.-	34526600	82.-
1016325-00	600,-	1016325-00	600,-

Central air discharge socket in Brilliant Silver with direct connection possibility (300 mm Ø) upwards. Channelling the air to the right, to the left or to the rear requires additional use of the curved profile (Art. No. 100001292).

90° curved profile in Brilliant Silver for routing the air discharge hose to the right, left or rear, including pipe adapter for direct connection to the central air discharge socket. Air ducting possible via direct 300 mm Ø air discharge hose connection.

Connection socket for 300 mm Ø air discharge hose

Air discharge hose 300 mm Ø, flexible, grey, 6 m, with 2 hose clips

Air discharge hose connector 300 mm Ø

Air discharge assembly for connecting to double rear panel

Add-on kit intermediate acrylic and fan for Affinity 700 Twin Power

AUDIO (for Affinity, Balance, Esprit, Prestige, Inspiration)

Wire set audio
(incl. channel selection)

Wire audio
(without channel selection)

Prod. ref. no.	Euro, excl. VAT	Prod. ref. no.	Euro, excl. VAT
500000160	38.-	500000161	20.-

ERGO LINE INSPIRATION

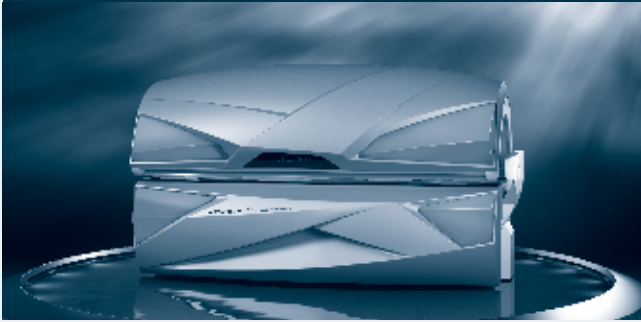

DIMENSIONS ERGO LINE INSPIRATION (in mm)

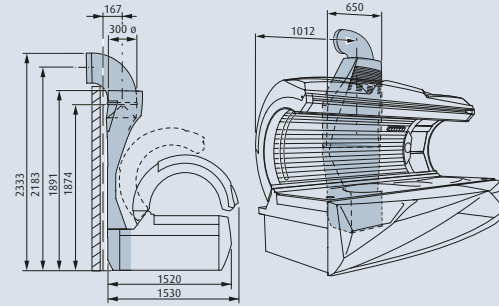

Central air discharge socket in Brilliant Silver with direct connection possibility (300 mm Ø) upwards. Channelling the air to the right, to the left or to the rear requires additional use of the curved profile (Art. No. 100001292).

90° curved profile in Brilliant Silver for routing the air discharge hose to the right, left or rear, including pipe adapter for direct connection to the central air discharge socket. Air ducting possible via direct 300 mm Ø air discharge hose connection.

Connection socket for 300 mm Ø air discharge hose

Air discharge hose 300 mm Ø, flexible, grey, 6 m, with 2 hose clips

Air discharge hose connector 300 mm Ø

Art. No. with warm air recovery	Euro, excl. VAT	Art. No. without warm air recovery	Euro, excl. VAT
50000892	795.-	50000893	655.-
100001292	158.-	100001292	158.-
34503600	19.-	34503600	19.-
34502800	107.-	34502800	107.-
34502700	26.-	34502700	26.-

ERGOLINE PASSION 300/350



DIMENSIONS ERGOLINE PASSION (IN MM)

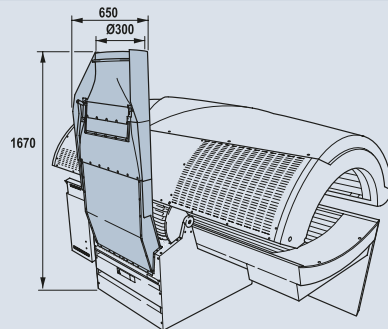

ERGOLINE AIR DISCHARGE SYSTEM PASSION 300/350

Art. No. with warm air recovery (manual)	Euro, excl. VAT	Art. No. without warm air recovery	Euro, excl. VAT
500000870	750.-	500000871	655.-
100001292	158.-	100001292	158.-
34503600	19.-	34503600	19.-
34502800	107.-	34502800	107.-
34502700	26.-	34502700	26.-

Central air discharge socket in Brilliant Silver with direct connection possibility (300 mm Ø) upwards. Channelling the air to the right, to the left or to the rear requires additional use of the curved profile (Art. No. 100001292).

90° curved profile in Brilliant Silver for routing the air discharge hose to the right, left or rear, including pipe adapter for direct connection to the central air discharge socket. Air ducting possible via direct 300 mm Ø air discharge hose connection.

Connection socket for 300 mm Ø air discharge hose

Air discharge hose 300 mm Ø, flexible, grey, 6 m, with 2 hose clips

Air discharge hose connector 300 mm Ø

**ERGO LINE ESSENCE 440
BEAUTY ANGEL CVT 32**

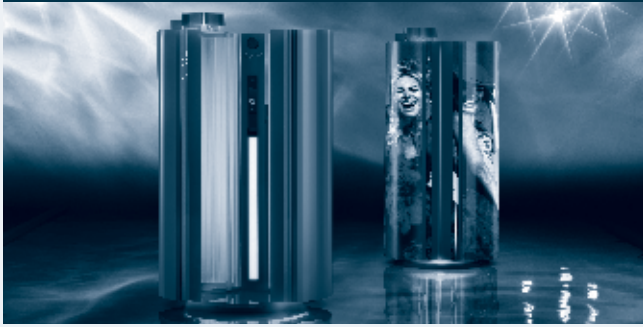

ERGO LINE AIR DISCHARGE SYSTEM ESSENCE 440 / CVT 32

	Art. No.	Euro, excl. VAT without warm air recovery
Central air discharge socket in Brilliant Silver with integrated air discharge motor	100002542	655.-
Connection socket for 150 mm Ø air discharge hose	500000942	38.-
Air discharge hose , Ø 150 mm, flexible, grey, 6 m, with 2 hose clips	500000940	91.-
Adapter , from Ø 150 mm to Ø 300 mm	500000941	38.-

ERGO LINE SUNRISE



ERGO LINE AIR DISCHARGE SYSTEM SUNRISE

	Art. No.	Euro, excl. VAT without warm air recovery
Air discharge box*	100001962	1,095.-
90° curved profile in Brilliant Silver	100001292	158.-
Air discharge hose 300 mm Ø, flexible, grey, 6 m, with 2 hose clips	34502800	107.-
Air discharge hose connector Ø 300 mm	34503600	19.-

DIMENSIONS AIR DISCHARGE BOX (IN MM)

Technical Data:

Total power consumption:
ca. 1,200 W
Line voltage: 230-240 V~3
Rated frequency: 50 Hz
Fuses (slow-blowing): ca. 1x16 A
Air consumption max.:
ca. 2,600 m³/h
(ambient temperature 25°C
and air in max. 40°C)

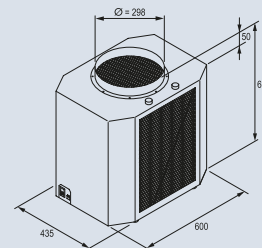

DIMENSIONS ERGO LINE SUNRISE, ESSENCE, CVT 32 (IN MM)

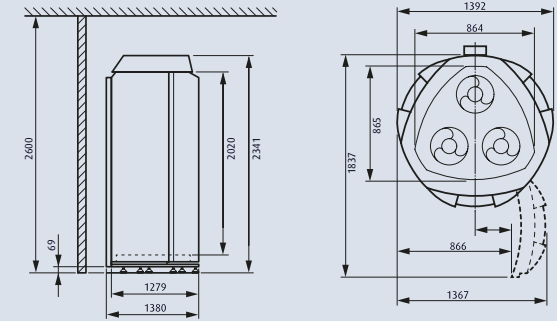

* Can be used for all sunbeds

PROFESSIONAL SUNBEDS
HYBRID UNITS
BEAUTY ANGEL

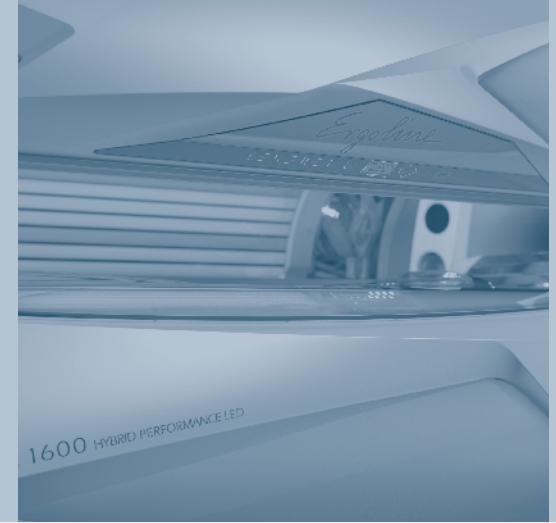

PROFESSIONAL SUNBEDS | HYBRID UNITS

AIR DISCHARGE SYSTEMS
ACCESSORIES



AIR DISCHARGE SYSTEMS | ACCESSORIES

CONTROL SYSTEMS
STUDIO EQUIPMENT



CONTROL SYSTEMS | STUDIO EQUIPMENT

ERGOLINE CONTROL SYSTEMS

ERGOLINE STUDIO PILOT

	Art. No.	Euro, excl. VAT
Studio Pilot¹: Central control unit for operating up to 25 sunbeds	34009900	2,430.-
Sunbed interface 1: Control module for each sunbed (also other producers)	34523700	327.-
TV interface: Control module for monitor or television (display of cabin booking)	34523800	815.-

¹ Only available in German-speaking countries and only available in German language

To operate the Studio-Manager Software the following requirements must be fulfilled:

- Computer interface is available according to Ergoline specifications
- Bus line to PC is laid and functional
- Power connection for computer (is connected to the computer) is laid and functional
- Internet-connection is available and functional

* Only possible with Studio-Manager and graphics card with 2 monitor outputs

** The Studio-Manager Version 2 is only to be operated with the Studio-Manager accessories listed by Ergoline!

ERGO LINE MANUAL REMOTE CONTROL SYSTEM

incl. 5 m control cable and plug (extra-low voltage), with master card and double shut-down safety facility according to EN 60335-2-27/A11:2002

	Art. No.	Euro, excl. VAT
Mikrocomputer MCS III plus	500000456	395.-
Adapter for connecting MCS controls (for Sunrise)	100001853	225,-

NFC-CARDS / NFC-TAGS

	Artikel-Nr.	Euro ohne MwSt.
Package NFC-Cards Prestige consisting of: 2 pcs. Professional Set-up Card, 2 pcs. LED Light Show, 2 pcs. ECO Tech	500001175	30.-
Package NFC-Cards Inspiration 600 consisting of: 2 pcs. Professional Set-up Card, 2 pcs. LED Light Show	500001178	20.-
Personal Comfort Card with 4-colour printing , 100 per unit	1014733-00	200.-
NFC-Tags with 4-colour printing , 100 per unit	1014735-00	150.-

ACCESSORIES FOR STUDIO-PILOT/STUDIO-MANAGER

For all Ergoline professional sunbeds

	Art. No.	Euro, excl. VAT
Brass tokens for Ergoline token box and Studio Pilot, 50 per unit	34005300	27.-
Chip cards with 4-colour printing for MCS VI, Studio Pilot and Studio-Manager, 100 per unit	34009500	305.-
Chip cards with 4-colour printing for MCS VI, Studio Pilot and Studio-Manager, 400 per unit	34524700	1.055.-
Chip card plain for MCS VI, Studio Pilot and Studio-Manager, 100 per uni	38000500	265.-
Salon card (personnel card) for MCS VI, Studio Pilot and Studio-Manager with 4-colour printing	34010100	10.-
Control cable Studio Pilot for multi-tasker bus (100 m run)	34510400	100.-
Document verification for MCS-token boxes and Studio Pilot	500000880	555.-
Computer-Interface for PC connection to control line	34590200	430,-

STUDIO EQUIPMENT

	Artikel-Nr.	Euro ohne MwSt.
Neon-Display Format: 90 x 45 x 17	19 004 81	249.-

